

BIO RECOVER

IL LEGNO
REINVENTATO
*WOOD
REINVENTED*



LEA
CERAMICHE



**LA NUOVA
DEFINIZIONE DEL LEGNO**

The new
meaning of wood



**BIO RECOVER
FULL BLUE
GOLDEN FLAME**

Parete / Wall
20x90cm / 8"x36" full blue



PUBLIC AREAS

BIO RECOVER PIED DE POULE BLUE GOLDEN FLAME

Pavimento / Floor
nat. rett. 20x180cm / 8"x71"
20x90cm / 8"x36" pied de poule blue





**BIO RECOVER
OLD WALNUT**

Pavimento / Floor
nat. rett. 20x180cm / 8"x71"

LIVING



BIO RECOVER FRAMMENTI WHITE WARM CREAM

Pavimento / Floor
nat. rett. 20x180cm / 8"x71"
12x20cm / 4³/₄"x8" frammenti white
8x20cm / 3¹/₈"x8" frammenti white
4x20cm / 1⁹/₁₆"x8" frammenti white



BIO RECOVER
FULL BLUE
GOLDEN FLAME

Parete / Wall
20x90cm / 8"x36" full blue

**BIO RECOVER
OLD WALNUT**

Pavimento / Floor
nat. rett. 20x180cm / 8"x71"





BATHROOM

BIO RECOVER
PIED DE POULE WHITE
GOLDEN FLAME

Parete / Wall
20x90cm / 8"x36" pied de poule white



BIO RECOVER
FULL RED
WARM CREAM

Pavimento / Floor
nat. rett. 20x180cm / 8"x71"
20x90cm / 8"x36" full red



FORMATI E COLORI

SIZES AND COLORS_FORMATS ET COULEURS_FORMATE UND FARBEN

DECORI

DECORS_DECORS_DEKORE

WARM CREAM

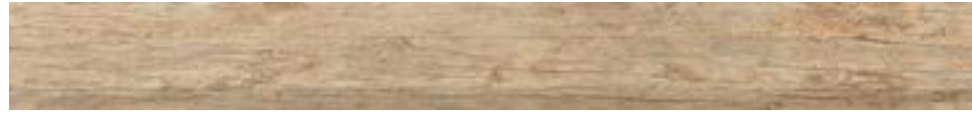

20x180cm / 8"x71"
nat. rett. (spessore 12mm)

LG4BR20



20x121,5cm / 8"x48"
nat. (spessore 10,5mm)

LGOBR20

GOLDEN FLAME



20x180cm / 8"x71"
nat. rett. (spessore 12mm)

LG4BR00



20x121,5cm / 8"x48"
nat. (spessore 10,5mm)

LGOBR00

OLD WALNUT



20x180cm / 8"x71"
nat. rett. (spessore 12mm)

LG4BR10



20x121,5cm / 8"x48"
nat. (spessore 10,5mm)

LGOBR10



FULL WHITE
20x90cm / 8"x36"
warm cream
golden flame
old walnut

LG3BRW2
LG3BRW0
LG3BRW1



FULL BLUE
20x90cm / 8"x36"
warm cream
golden flame
old walnut

LG3BRB2
LG3BRB0
LG3BRB1



FULL RED
20x90cm / 8"x36"
warm cream
golden flame
old walnut

LG3BRF2
LG3BRF0
LG3BRF1



PIED DE POULE WHITE
20x90cm / 8"x36"
warm cream
golden flame
old walnut

LG3BRP2
LG3BRP0
LG3BRP1



PIED DE POULE BLUE
20x90cm / 8"x36"
warm cream
golden flame
old walnut

LG3BRD2
LG3BRD0
LG3BRD1

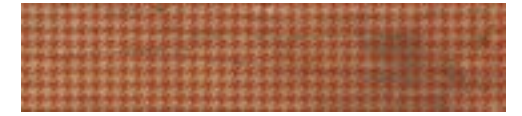

PIED DE POULE RED
20x90cm / 8"x36"
warm cream
golden flame
old walnut

LG3BRR2
LG3BRR0
LG3BRR1



FRAMMENTI WHITE
4x20cm - 8x20cm - 12x20cm / 1/16"x8" - 3/16"x8" - 4/14"x8"
warm cream
golden flame
old walnut

LGMBRW2
LGMBRW0
LGMBRW1



FRAMMENTI BLUE
4x20cm - 8x20cm - 12x20cm / 1/16"x8" - 3/16"x8" - 4/14"x8"
warm cream
golden flame
old walnut

LGMBRB2
LGMBRB0
LGMBRB1



FRAMMENTI RED
4x20cm - 8x20cm - 12x20cm / 1/16"x8" - 3/16"x8" - 4/14"x8"
warm cream
golden flame
old walnut

LGMBRR2
LGMBRR0
LGMBRR1

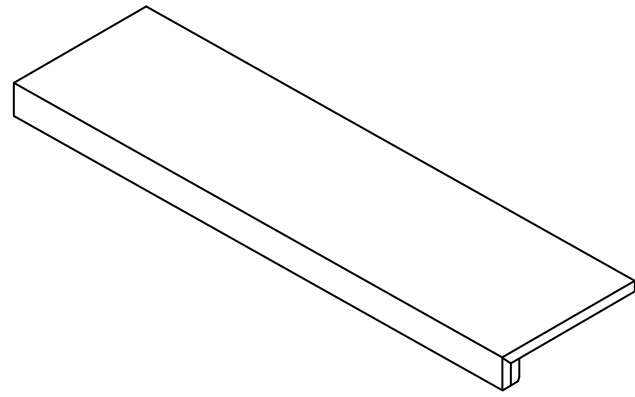

ANGOLO SX GRADINO PLUS*
35x120cm / 13^{3/4}"x48"
golden flame LG9BR50
old walnut LG9BR51
warm cream LG9BR52

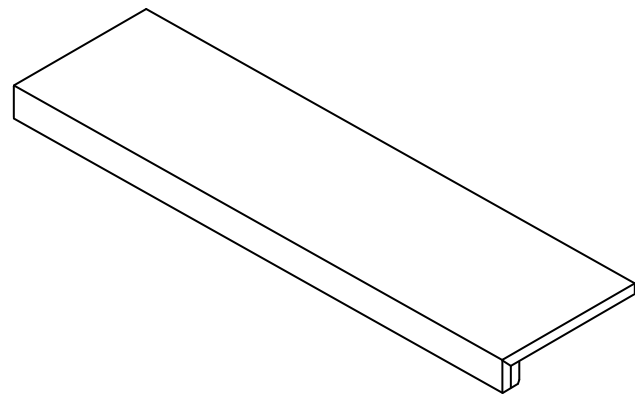

GRADINO PLUS*
35x120cm / 13^{3/4}"x48"
golden flame LG9BRP0
old walnut LG9BRP1
warm cream LG9BRP2

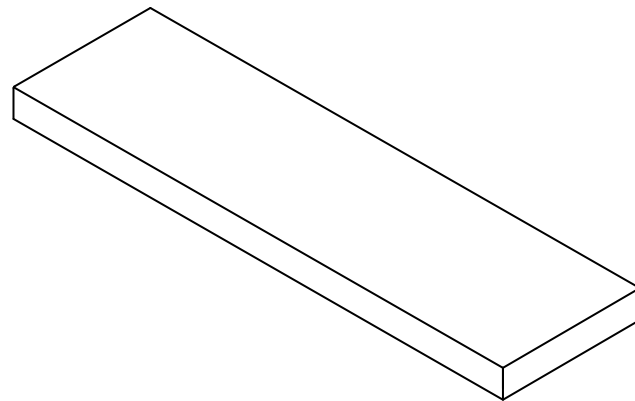
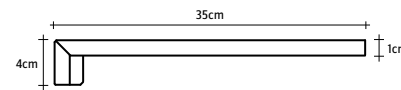

ANGOLO DX GRADINO PLUS*
35x120cm / 13^{3/4}"x48"
golden flame LG9BRD0
old walnut LG9BRD1
warm cream LG9BRD2

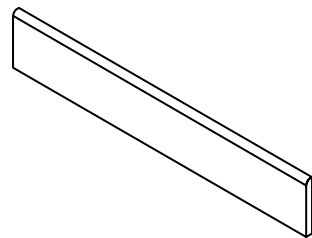

BATTISCOPIA
10x60cm / 4"x24"
golden flame LGBBR00
old walnut LGBBR10
warm cream LGBBR20

*su richiesta. Per maggiori informazioni circa quantità minime e tempi di consegna rivolgersi all'ufficio commerciale. - upon request. For more information about minimum quantities and delivery times please contact the sales department. - sur demande. Pour plus d'informations sur les quantités minimales et délais de livraison s'il vous plaît contacter le département des ventes. - auf Anfrage. Für weitere Infos über die Mindestmengen und Lieferzeiten wenden Sie sich bitte an unserer Verkaufsabteilung. - bajo pedido. Para mayor información sobre la cantidad mínima y plazo de entrega contactar nuestra oficina comercial.

**BIO RECOVER
PIED DE POULE WHITE
GOLDEN FLAME**

Parete / Wall
20x90cm / 8"x36" pied de poule white







BIO RECOVER

gres tutta massa UGL









full-body porcelain
grès cérame en pleine masse
vollgemischtes durchgefärbtes feinsteinzeug

spessore 10,5mm / 12mm

thickness
épaisseur
stärke

CARATTERISTICHE TECNICHE* TECHNICAL CHARACTERISTICS CARACTÉRISTIQUES TECHNIQUES TECHNISCHE EIGENSCHAFTEN	metodo di prova test method methode d'essai prüfmethode	valori medi average values valeurs moyens durchschnittliche werte
 assorbimento d'acqua (E) water absorption (E) absorption d'eau (E) wasserabsorption (E)	ISO 10545-3	≤ 0,04%
 resistenza al gelo frost resistance résistance au gel frostbeständigkeit	ISO 10545-12	resistente résistant beständig
 resistenza alla flessione bending strength résistance à la flexion beigefestigkeit	ISO 10545-4	≥ 50 N/mm ²
 sforzo di rottura (S) breaking strength (S) chargement de rupture (S) bruchlast (S)	ISO 10545-4	spess. 10,5mm: ≥ 2500 N spess. 12mm: ≥ 3000 N
 resistenza all'abrasione profonda résistance to deep abrasion résistance à l'abrasion profonde widerstand gegen tiefenabrier	ISO 10545-6	≤ 145 mm ³
 dilatazione termica lineare thermal expansion dilatation thermique linéaire thermische dilatation	ISO 10545-8	$\alpha \leq 7 \times 10^{-6} \text{ } ^\circ\text{C}^{-1}$
 resistenza agli sbalzi termici thermal shock resistance résistance aux chocs thermiques temperatur wechselbeständigkeit	ISO 10545-9	resistente résistant beständig
 resistenza attacco chimico chemical resistance résistance chimique chemischee beständigkeit	ISO 10545-13	UHA, ULA resistente résistant beständig
 resistenza alle macchie stain resistance résistance aux taches fleckenbeständigkeit	ISO 10545-14	5 resistente résistant beständig
 resistenza allo scivolamento slip resistance résistance au glissement rutschfestigkeit	DIN 51130	R10
 resistenza allo scivolamento slip resistance résistance au glissement rutschfestigkeit	DIN 51097	B (A+B)
 coefficiente di attrito dinamico dynamic friction coefficient coefficient de friction dynamique dynamischer reibungskoeffizient	B.C.R. tortus	$\mu > 0,40$
 dynamic coefficient of friction (DCOF)	ANSI A 137.1:2012	DCOF ≥ 0.42
 stonalizzazione shading denuançage spieifarbig		V4

*ISO 13006-G Bla UGL – EN 14411-G Bla UGL – ANSI A 137.1 (Unglazed Porcelain Tiles - Class P1)

IMPIEGHI USES EMPLOI ANWENDUNGSBEREICHE		
 alberghi hotels hotels hotels		locali pubblici public spaces lieux publics öffentliche bereiche
 abitazioni housing maisons wohnbereiche		aeroporti airports aéroports flughafen
 bar - ristoranti bar - restaurants bar - restaurants cafés - restaurants, gasthäuser		centri commerciali malls centre commerciaux einkaufszentren
 negozi shops magasins geschäfte		stazioni train stations gares bahnhöfe

IMBALLAGGI PACKING EMBALLAGE VERPACKUNGEN

articolo	scatola			europallet			
	pz.	mq	kg	scat.	mq	kg	
fondo 20x180	8"x71"	3	1,08	30,0	48	51,8	1440,0
fondo 20x121,5	8"x48"	5	1,22	29,0	24	29,2	696,0
decoro full 20x90	8"x36"	4	0,72	20,0	40	28,8	800,0
dec. pied de poule 20x90	8"x36"	4	0,72	20,0	40	28,8	800,0
decoro frammenti -	-	6	0,29	9,0	96	27,6	864,0
battiscopa 10x60	4"x24"	12	7,2 m.l.	16,0	56	403,0 m.l.	896,0
gradino plus 35x120	13 ³ / ₄ "x48"	2	0,84	23,2	16	13,4	371,2
angolo gradino plus 35x120	13 ³ / ₄ "x48"	1	0,42	12,4	16	6,7	198,4



ISO 14001



ISO 9001



emas

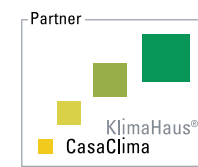

casaclima



leed

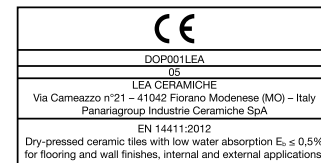

marchio CE



leed

* LEED
Lea Ceramiche, tramite la holding Panariagroup Industrie Ceramiche S.p.A., è socio ordinario del Green Building Council e del GBC Italia. Through Panariagroup Industrie Ceramiche S.p.A., Lea Ceramiche is an ordinary member of the Green Building Council and the GBC Italia. Par le biais de Panariagroup Industrie Ceramiche S.p.A., Lea Ceramiche est membre ordinaire du Green Building Council et du GBC Italia. Lea Ceramiche, durch die Holding Panariagroup Industrie Ceramiche S.p.A., ist ordentliches Mitglied von dem Green Building Council und dem GBC Italien. Lea Ceramiche, a través del holding Panariagroup Industrie Ceramiche S.p.A., es miembro afiliado del Consejo Construcción Verde y del Consejo Construcción Verde de Italia.

** LEED
Il contenuto di materiale riciclato "pre-consumo" della serie Bio Recover è del 40%, come certificato da ente esterno qualificato (certificato disponibile sul sito www.ceramichelea.com). Bio Recover is produced with 40% of pre-consumer materials, as certified by a qualified external company (certificate available on the website www.ceramichelea.com).

*** CASACLIMA
Lea Ceramiche, tramite la holding Panariagroup Industrie Ceramiche S.p.A., ha ottenuto la certificazione Partner Casaclima. Through Panariagroup Industrie Ceramiche S.p.A., Lea Ceramiche has obtained the Partner Casaclima certification. Par le biais de Panariagroup Industrie Ceramiche S.p.A., Lea Ceramiche a obtenu la certification Partner Casaclima. Lea Ceramiche, durch die Holding Panariagroup Industrie Ceramiche S.p.A., hat die Bescheinigung als Partner Casaclima bekommen. Lea Ceramiche, a través del holding Panariagroup Industrie Ceramiche S.p.A., ha obtenido la certificación Partner Casaclima.



ADI MEMBER



**LEA CERAMICHE HA SCELTO MICROBAN®,
IL LEADER MONDIALE NELLA PROTEZIONE ANTIBATTERICA**
*LEA CERAMICHE CHOOSES MICROBAN®,
THE GLOBAL LEADER IN ANTIMICROBIAL TECHNOLOGY*

PROTEZIONE 24 ORE SU 24
24/7 COVERAGE

EFFICACE CONTRO MACCHIE E ODORI CHE CAUSANO BATTERI
EFFECTIVE AGAINST STAIN AND ODOR CAUSING BACTERIA

MOLTEPLICI APPLICAZIONI ED UTILIZZI
MULTIPLE APPLICATIONS

TRATTAMENTO PERMANENTE
PERMANENT PROTECTION

INTEGRATA NELLA PIASTRELLA
INTEGRATED IN THE TILE

EFFICACE SU OGNI SUPERFICIE
EFFICIENT ON ANY SURFACE

BIO RECOVER

IL LEGNO
REINVENTATO
WOOD
REINVENTED



LEA

CERAMICHE

LEA CERAMICHE
Via Cameazzo, 21
41042 Fiorano Modenese
Modena Italy

Tel +39 0536 837811
Fax +39 0536 830326
info@ceramichelea.it
www.ceramichelea.com

Panariagroup Industrie Ceramiche
S.p.A.

SHOWROOM LEA CERAMICHE
Via Durini, 3
20122 Milano

Tel +39 02 76011406
showroom_milano@ceramichelea.it

LEA NORTH AMERICA, LLC
800 Clanton Road, Suite N
Charlotte, NC 28217

Tel +1 704 522 6300
Fax +1 704 522 6080
info@leausa.us
www.leausa.us